

ORDER FORM

Messeaufbauten

Werner Klos

Messeaufbauten Werner Klos GmbH & Co. KG

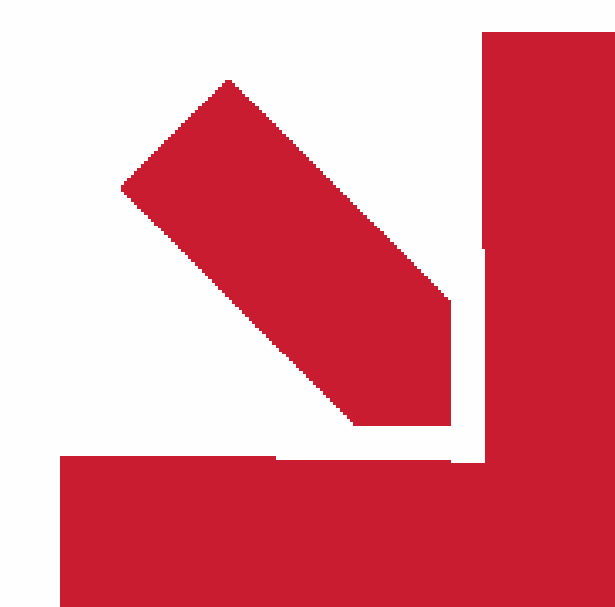

For Fair	
Hall	Stand-No.

Company Name:

Street:

Postcode, City:

Country:

Contact Person:

Phone:

Fax:

E-Mail:

VAT ID No.:

Rental Furniture and Additional Stand Fixtures

Item No.	Quantity	Article	Unit Price €	Total Price €	Item No.	Quantity	Article	Unit Price €	Total Price €
194,196		Armchair black or white, 70cm w	79,00		Stand Construction Material „Brown, not wallpapered“				
195,197		Couch black or white, 120cm w	125,00		50		Exhibition Wall, 2,50m h à m.	26,00	
190		Club Table round, matches No. 194-197	47,00		53		Stand Screen, 0,25m h à m.	14,00	
192		Bistro Table white	93,50		52		Support à pc.	13,50	
121		Chair upholstered, grey with arm rests	23,50		51		Door Element, 1,00m w à pc.	65,50	
120		Chair upholstered, grey without arm rests	22,50		Stand Construction Material „White“				
127		Moulded Chair plastic anthracite	20,00		40		Exhibition Wall, 2,50m h à m.	33,00	
126		Chair, white wooden seat	24,00		44		Stand Screen, 0,25m h à m.	20,50	
134		Bar Stool trestle chrome, seat black	45,50		43		Support à pc.	16,50	
133		Bar Stool white, wooden seat	37,50		41		Door Element, 1,00m w à pc.	104,50	
132		Z-Bar Stool white or black	31,00		Stand Construction Material „System, white“				
130		Swivel Arm Chair white or black	42,00		1		System Wall Element, 2,50m h à m.	44,00	
131		Counter Chair height adjustable, with rollers	37,50		11		System Lattice Girder, 0,28m h à m.	30,00	
140		Table white top, 50x50cm	20,00		9		Support à pc.	24,50	
141		Table white top, 60x60cm	23,50		6		System Door Element, 1,00m w à pc.	126,50	
142		Table white or beech top, 70x70cm	30,00		20		System Ceiling Grid, 1mx1m à m²	35,00	
143		Table white or beech top, 140x70cm	35,50		14		System Folding Wall, 2m h, 3m w à pc.	104,50	
147		Stand Up Table white or beech, 60cm Ø	53,50		13		Rack, aluminium, angular or straight 1,00m w x 30cm d à m.	24,50	
144-146		Model Table 70x70cm/60 or 80cm Ø	50,50						
148		Folding Table 195/200 x 55/65cm	20,00		Lighting				
149		Folding Table 150 x 55/65cm	18,50		100		Exhibit Lighting, 120W à pc.	49,50	
150		Desk white	64,00		101		Exhibit Lighting, 230W à pc.	55,00	
215		Dustbin 33cm h, 30cm Ø	10,50		102		Power Track Mounted HQI Spotlight à pc.	60,50	
219		PC Desk white with beech top	74,00		Flooring				
217		File Cabinet white, 119x82x40cm	57,50		97		Rewind Rib, incl. laying, fixing + covering foil, recyclable colours: black, anthracite, grey, white, brown, beige, yellow, orange, dark green, light green, dark red, light red, light blue, blue, dark blue, fuchsia m long x m wide à m²	12,00	
210		Coat Rail	29,00						
212		Sales Rack	47,50						
180		Refrigerator approx. 150 l	77,00						
181		Refrigerator approx. 270 l	121,00						
214		Brochure Stand small, white	60,50		Counters				
213		Shelf white or beech	71,00		160-161		Syma Information Counter 0,5/1m w à m.	121,00	
216		Tensator 3m tension band, à pc.	25,00		162		Syma Information Counter white, 1,5m w	143,00	
Display Cases					164		Syma Corner Counter white	269,50	
240		Stand Display Case lower cabinet, 1,7m h	236,50		168		Syma Sales Counter white, 1m w	121,00	
245		Column Glass Cabinet 52,5cm w, 2,5m h	236,50		163		Syma Info Counter, model 2 white, 1m w	112,50	
246		System Display Case lower cabinet, 1,13m h	203,50		170		Syma Sales Counter, model 2 white, 1m br	101,50	
247		Table Display Case flat, 1,01m h	137,50						
242		Glass Cabinet Display Case 1,9m h	264,00						

Messeaufbauten Werner Klos GmbH & Co. KG

Rudolf-Diesel-Straße 68
Telefon: +49 (0)2303 2462
www.messebau-klos.de

59425 Unna
Fax: +49 (0)2303 2461
info@messebau-klos.de

Bank Details:

Sparkasse UnnaKamen: Swift WELADED1UNN IBAN DE54 4435 0060 0003 0048 76
Our VAT ID No.: DE 124870983
Delivery will be carried out to the terms and conditions of business and payment declared on the back side.

These and further articles are listed with photos and sizes on our homepage at www.messebau-klos.de



Rental Ready Stands

please mark:

System Item No. 260

Price per square metre:
107,00€ (plus VAT)



Exhibition Materials according to example picture

- 8 m. System Wall Elements
- 1 pc. System Door Element
- 7 m. System Lattice Girder, 1 Support
- 4 pcs. Exhibit Lightings, 120W
- 12m² Ribbed Carpet
- 1 pc. Coat Rail
- 1 pc. Shelf
- 1 pc. Syma Information Counter, 1m wide
- 1 pc. Z-Bar Stool
- 1 pc. Model Table, top 60cm Ø
- 4 pcs. Chairs, upholstered, without arm rests
- 1 pc. Screen Lettering 2450mm w x 220mm h

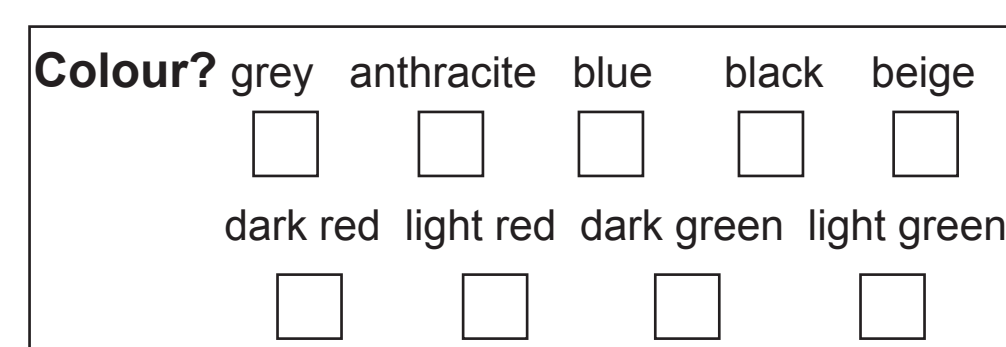
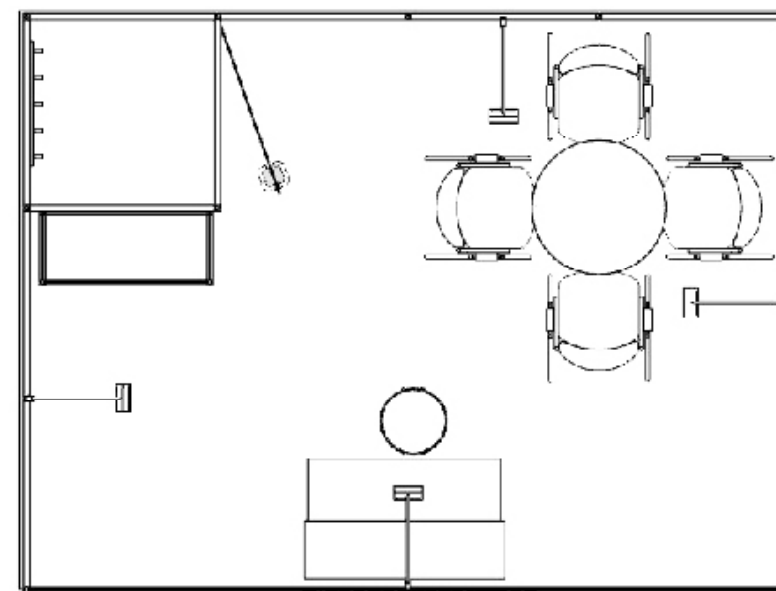

please mark:

System Tower Item No. 261

Price per square metre:
95,00€ (plus VAT)

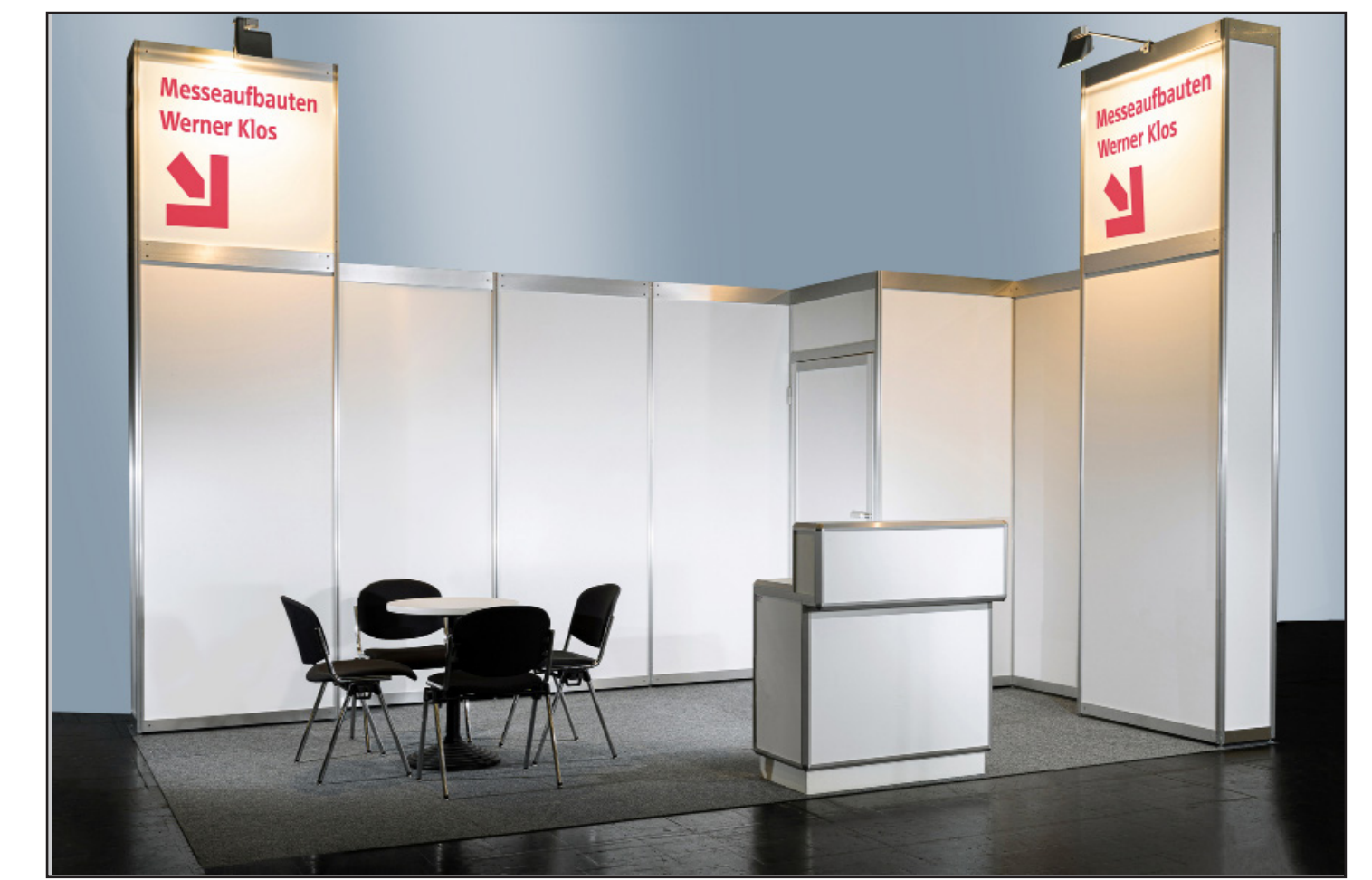

Exhibition Materials according to example picture

- 13m. System Wall Elements
- 1 pc. System Door Element
- 2 pcs. Tower Extension, 1m high
- 2 pcs. Exhibit Lightings, 230W
- 15m² Ribbed Carpet
- 1 pc. Coat Rail
- 1 pc. Shelf
- 1 pc. Syma Information Counter, 1m wide
- 1 pc. Model Table, top 60cm Ø
- 4 pcs. Chairs, upholstered, without arm rests
- 1 pc. Z-Bar Stool
- 2 pcs. Graphic Tower Filling 960mm w x 900mm h

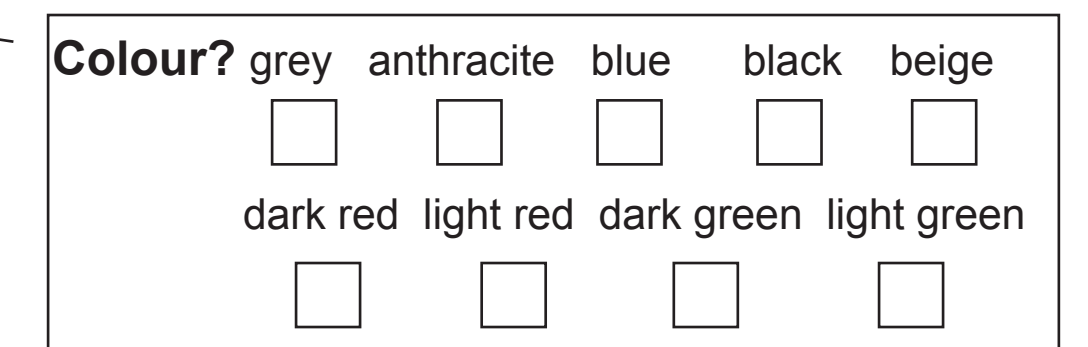
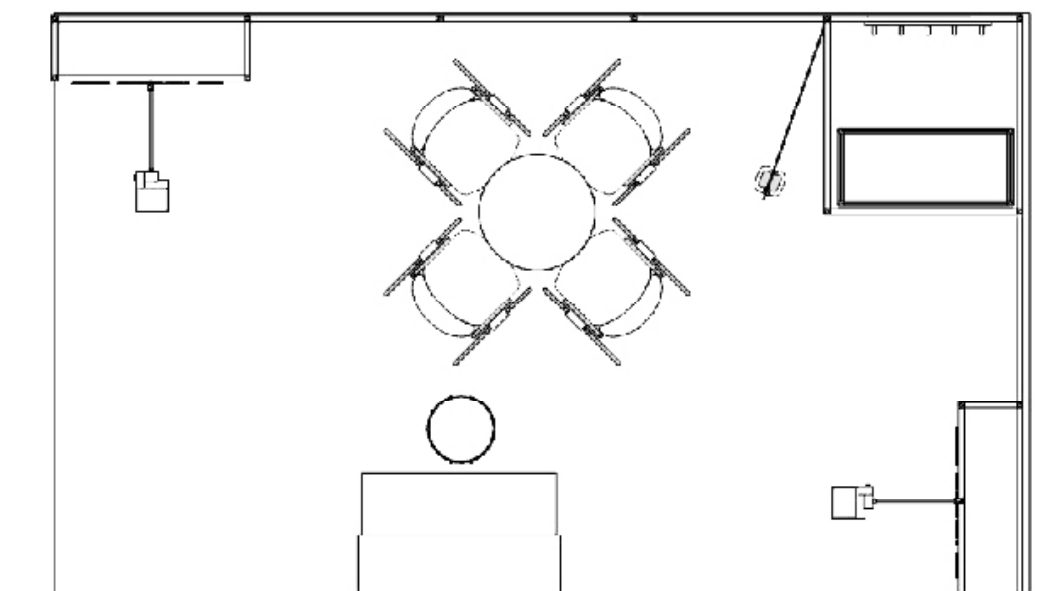

please mark:

Quadralite Item No. 262

Price per square metre:
114,00€ (plus VAT)



Exhibition Materials according to example picture

- 9 m. System Wall Elements
- 1 pc. System Door Element
- 23m. Quadralite Construction
- 4 pcs. Quadralite Construction Head Pieces
- 4 pcs. HQI Spotlights
- 24m² Ribbed Carpet
- 1 pc. Shelf
- 1 pc. Coat Rail
- 1 pc. Syma Information Counter, 1m wide
- 4 pcs. Z-Bar Stools
- 1 pc. Stand Up Table, round
- 1 pc. Model Table, top 60cm Ø
- 4 pcs. Chairs, upholstered, without arm rests

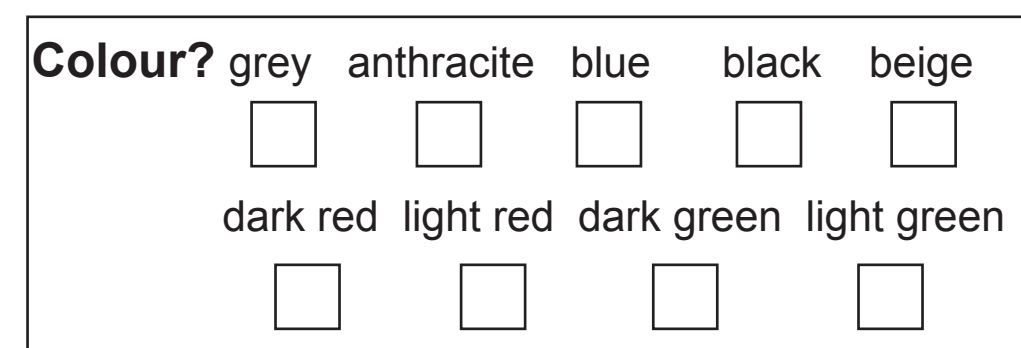
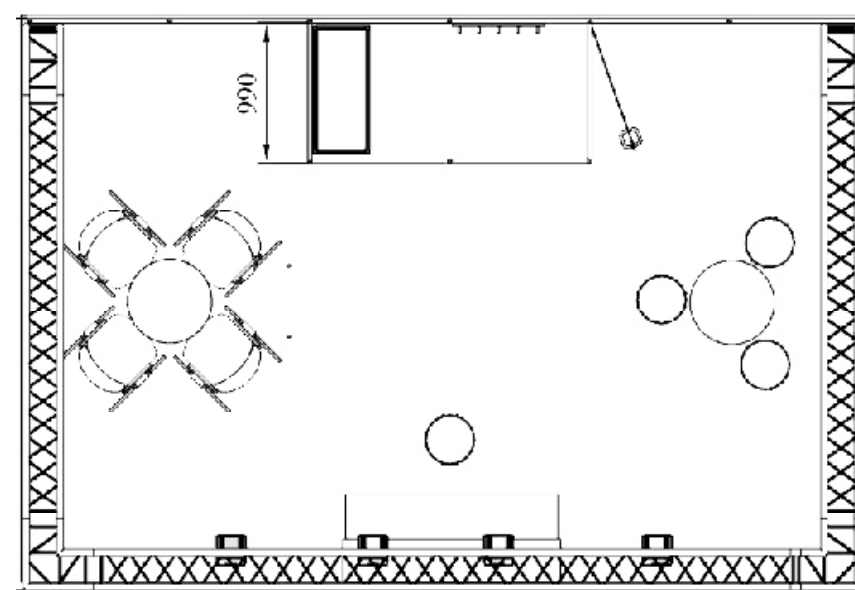

please mark:

Molto Tower Item No. 263

Price per square metre:
120,00€ (plus VAT)

Exhibition Materials according to example picture

- 12m. „Molto“ Walls
- 1 pc. „Molto“ Door
- 1 pc. „Molto“ Tower, 2mx1m
- 1 pc. Ceiling Sails, white
- 2 pcs. Halogen Spotlights, 120W
- 3 pcs. Exhibit Lightings, 120W
- 1 pc. Exhibit Lighting, 230W
- 18m² Ribbed Carpet
- 1 pc. Shelf
- 1 pc. Refrigerator, 150l
- 4 pcs. Z-Bar Stools
- 1 pc. Syma Information Counter, 1m wide
- 1 pc. Brochure Stand, small
- 1 pc. Stand Up Table, round
- 1 pc. Model Table, top 60cm Ø
- 3 pcs. Chairs, upholstered, without arm rests
- 1 pc. Graphic „Molto“ Tower Filling 1890mm w x 900mm h

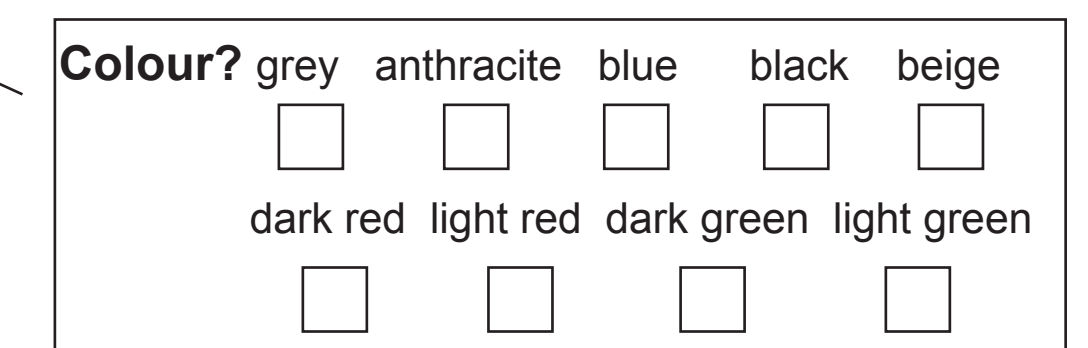
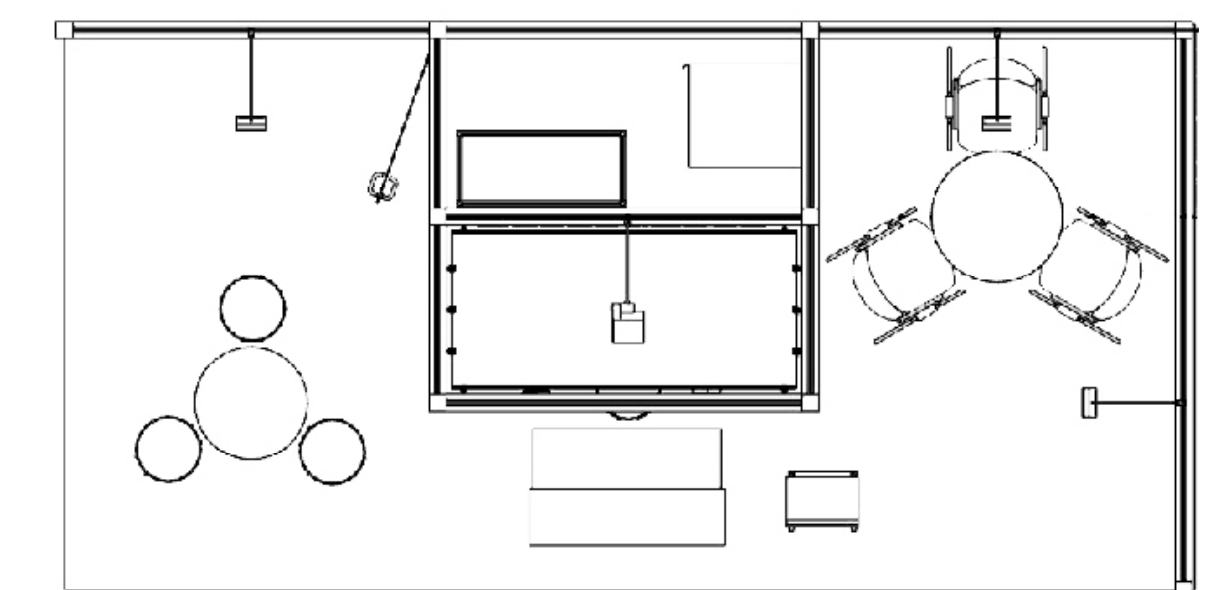

please mark:

Molto Item No. 264

Price per square metre:
109,00€ (plus VAT)



Exhibition Materials according to example picture

- 11 m. „Molto“ Walls
- 1 pc. „Molto“ Door
- 3 m² „Molto“ Ceiling Element, white
- 3 pcs. Recessed Spotlights
- 1 pc. Exhibit Lightings, 120W
- 15m² Ribbed Carpet
- 1 pc. Coat Rack
- 1 pc. Refrigerator, 150l
- 1 pc. Syma Information Counter, 1m wide
- 1 pc. Z-Bar Stool
- 1 pc. Model Table, top 60cm Ø
- 3 pcs. Chairs, upholstered, without arm rests

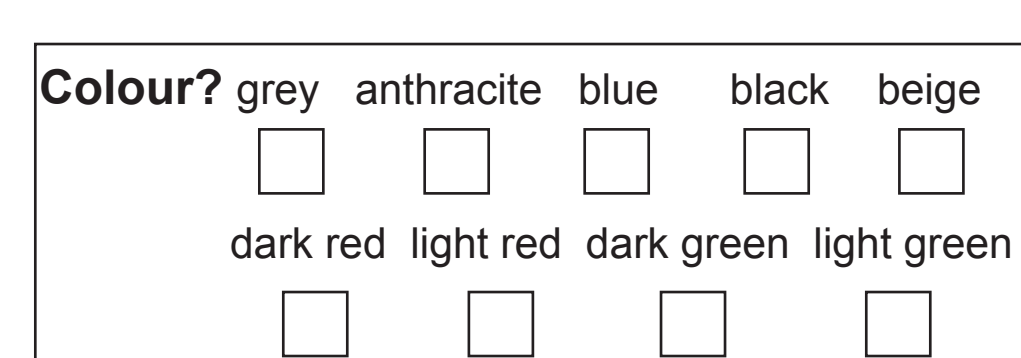
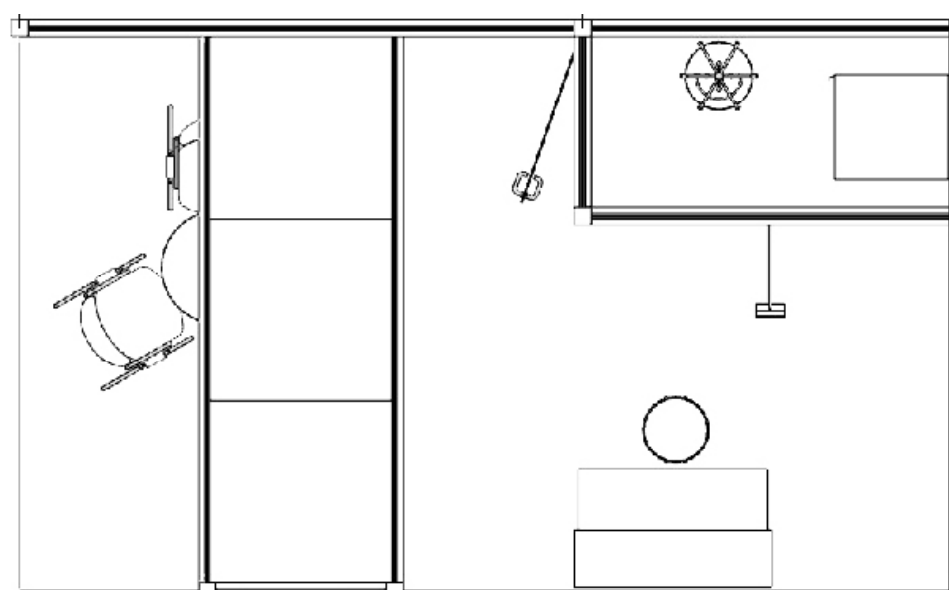

Desired delivery date:

Subtotal	EUR	
+ _____% VAT	EUR	
Total	EUR	

The given prices are net prices. VAT is calculated separately.
Prices are listed per piece / unit and generally apply to the duration of the exhibition.

The rental terms are noted and hereby acknowledged as legally binding.

Location / Date

Lessee (Stamp / Signature)

plus 20% surcharge from two weeks before the start of the trade fair

The main connections for electricity and water must be ordered separately.



General Terms and Conditions Dated 01.01.2024

1. Ordering

1.1 By sending back the signed order form or offer the customer places a binding order. The correct and complete invoice address and possible order numbers or departments or persons must be given together with the order.

1.2 The General Terms and Conditions are part of the placed order.

1.3 The services are executed as agreed in the contract. Messeaufbauten Klos reserves the right to minor variations with regard to the dimension, form and colour.

1.4 The customer is made aware that the rental items are used several times and are not always new. Normal signs of wear and usage which are due to the use of the item as a rental object do not represent grounds for complaints.

1.5 Orders must be placed at least 2 weeks prior to the beginning of the fair. Otherwise we do charge a surcharge of 20% of the net contract value.

1.6 Messeaufbauten Klos reserves the right in case of capacity shortage to deliver replacement goods of equal or better value to renter instead of the goods originally ordered. Claims cannot be made based on such replacement deliveries.

1.7 In case the ordered service is already carried out within the framework of the official setting-up time the cancellation fee, even in case of force majeure, is 100% of the net value contract.

2. Execution of the ordered service

2.1 The rental goods are provided only for the agreed purpose and agreed period of time.

2.2 Transport costs are normally included in the price for the site of Messe Dortmund. For different sites an additional fee can be charged.

2.3 Delivery of all orders without a certain date will be made before the commencement of the trade fair at the latest.

Fixed deadlines require the explicit agreement and written confirmation of Messeaufbauten Klos.

2.4 If there are no staff at the exhibition stand upon delivery the service is deemed to be rendered properly with the placement of the delivered goods at the exhibition stand.

2.5 The exhibitor shall be liable from that moment for decay and decline, in particular for any damage or loss. It is recommended that the customer concludes an exhibition insurance policy.

2.6 The customer must verify the proper condition, road safety and completeness of the services before making use of the services. Complaints must be communicated to Messeaufbauten Klos while the event is still in progress so that Messeaufbauten Klos has the opportunity to provide a remedy or at least make an orderly inspection of the complaint on site.

2.7 Short-term and additionally ordered services on site will be charged at the hourly rate.

2.8 Early return of the rental objects does not lead to a refund claim.

2.9 Messeaufbauten Klos is not obligated to verify the authorisation of the persons at the exhibition stand.

3. Prices, Terms of payment, Default

3.1 The prices shown in the price lists are the net prices valid for the duration of the respective trade fair. The respective statutory value added tax must also be paid.

3.2 A discount deduction is not allowed.

3.3 The invoices will be sent in electronic form by e-mail in PDF format.

Unless a different form of delivery was agreed previously.

3.4 Invoices are generally due for payment by the beginning of the trade fair, unless otherwise stated on the invoice.

All invoice amounts must be transferred upon receipt of the invoice (or if applicable within the payment period noted on the invoice) without discount and indicating the customer number and the invoice number to one of the accounts stipulated on the invoice.

3.5 Foreign customers are obliged to pay not later than two weeks before the start of the trade fair in Euro. Transfer charges of the banking institution are for account of the customer.

3.6 To receive the invoice without the German value added tax, foreign customers must state their correct and full VAT-ID-number or submit an applicable official certification not later than three weeks before the start of the trade fair.

3.7 Invoices for orders during a trade fair must be settled immediately upon receipt. The payment can only be effected in cash.

3.8 If invoices are addressed to a third party on instruction of the customer, then the customer still remains the debtor until the respective invoice is settled in full. Invoice changes, which are made after an invoice is issued at the request of the customer, are invoiced to the customer at a flat-rate fee of € 30,00 excluding the German value added tax for each reissued invoice.

3.9 The customer shall be regarded as being in default of payment without a reminder upon expiry of the payment term.

4. Force majeure

Force majeure, which prevents Messeaufbauten Klos from fulfilling all or some of its contractual services, and is therefore the performance of the contract impossible or excessively difficult to realise, then Messeaufbauten Klos is entitled to withdraw from the contract. Messeaufbauten Klos shall inform the customer immediately, unless it is also prevented from doing so due to force majeure. Where it is not possible to obtain an adequate supply of resources such as power, water etc., or in the event of strikes and lock-outs, the outbreak of an epidemic or pandemic, as well as terror attacks, these incidents can be compared to cases of force majeure.

5. Liability of Messeaufbauten Klos

Messeaufbauten Klos shall not be liable, subject to the following restrictions, for any breaches of duty:

Messeaufbauten Klos shall be liable in cases involving the loss of life, physical injury or damage to health, which are due to an intentional or negligent breach of duty by Messeaufbauten Klos, or by a legal representative or by an agent of Messeaufbauten Klos. Messeaufbauten Klos shall be liable for other damage which is caused by an intentional or a grossly negligent breach of duty by Messeaufbauten Klos, or by a legal representative or by an agent of Messeaufbauten Klos. The liability of Messeaufbauten Klos shall not be excluded in the event of a breach of essential contractual obligations, which Messeaufbauten Klos must guarantee according to the content, nature and purpose of the contract and on whose fulfilment the customer regularly relies and may rely, because they allow the proper implementation of the contract.

If the liability of Messeaufbauten Klos is excluded, this provision shall also apply to the personal liability of legal representatives or agents of Messeaufbauten Klos.

6. Liability of the customer

6.1 The customer shall be liable for the consequences arising from the inaccurate, incomplete or erroneous completion of the order form.

6.2 The liability of the customer for damages to and losses of the objects transferred to the customer begins at the moment of the handover and ends when the goods are picked up by Messeaufbauten Klos, even when the customer has already vacated the booth.

6.3 The customer is obligated to handle the objects provided with due care.

6.4 Rental furniture not returned and lost goods will be invoiced in the amount of their replacement value.

7. Wall elements, Carpet

7.1 Wall materials of the type „Exhibition wall, brown, not wallpapered“ are permitted to be wall papered or covered with textiles by the exhibitor or by firms commissioned by the exhibitor. The glues used for this purpose must guarantee that the wallpaper can be completely removed by the exhibitor or by a firm commissioned by the exhibitor at the end of the event. It is forbidden to paint or poster the blank wall material in its not-wallpapered state. Damaged wall material must be repaired; the cost of repair will be invoiced to the customer. Walls not properly cleaned incur a cleaning fee in the amount € 1,50 per m² visible surface area which will be invoiced to the customer.

7.2 The only means permitted to be used by the exhibitor or by firms commissioned by the exhibitor to attach posters etc. to the wall materials of the types „Exhibition wall, white“ and „System wall element, white“ are normal office tapes or Powerstrip. It is forbidden to use nails or screws or stronger adhesive tapes on this wall material. Damaged wall material must be repaired; the cost or repair will be invoiced to the customer. Walls not properly cleaned incur a cleaning fee in the amount € 1,50 per m² visible surface area which will be invoiced to the customer.

7.3 Disposal of broadloom carpet is not included in the price.

8. Lettering/Graphics

8.1 Messeaufbauten Klos shall accept no liability for the loss of or damage to any kind of printing templates submitted by the customer for the production of lettering.

8.2 If data files provided by the customer contain information regarding the colour tones to be printed, they must be designed in such a way that printing can be effected without any additional changes using the 4-colour printing process (CMYK). Besides data files must be created by the customer according to the size of each respective element which shall be lettered.

On request, Messeaufbauten Klos shall make available the leaflet „Printing Data“.

8.3 In case the customer provides unprintable or incomplete data files, additional costs can incur and shall be invoiced separately to the customer at the respective applicable prices.

8.4 If the data submission deadline set by Messeaufbauten Klos is exceeded, Messeaufbauten Klos can not guarantee finishing on-time.

9. Data protection

Data protection is taken seriously at Messeaufbauten Klos. In Messeaufbauten Klos's privacy policy, which you can find at www.messebau-klos.de, we set out our general bases for the protection of your personal data.

10. Applicable law, Place of fulfilment, Jurisdiction

10.1 The entire legal relationships between Messeaufbauten Klos, its employees, subcontractors and vicarious agents on one side and the customer, its employees, subcontractors and vicarious agents on the other side are exclusively governed by the law of the Federal Republic of Germany.

10.2 The place of fulfilment shall be Unna.

10.3 The jurisdiction for both contractual partners is, depending on the competent jurisdiction, the District Court of Unna or the Regional Court of Dortmund.

Messeaufbauten Werner Klos GmbH & Co. KG

Rudolf-Diesel-Str. 68

59425 Unna

Tel: +49 2303 2462

Fax: +49 2303 2461

info@messebau-klos.de

www.messebau-klos.de